

Solenoid operated valves pilot operated poppet type

2-way normally closed

Common cavity, Size 08

VEI-8A-06-NC

OD.15 - X - Y - Z - S

RE 18323-02

Edition: 03.2016

Replaces: 10.2013

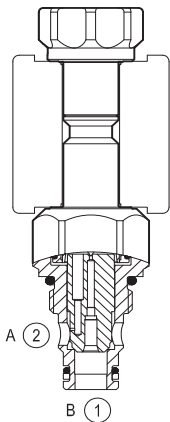

▼ Version 1

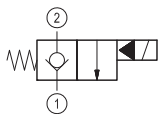

▼ Version 2

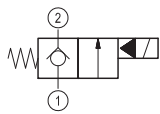

▼ Version 3

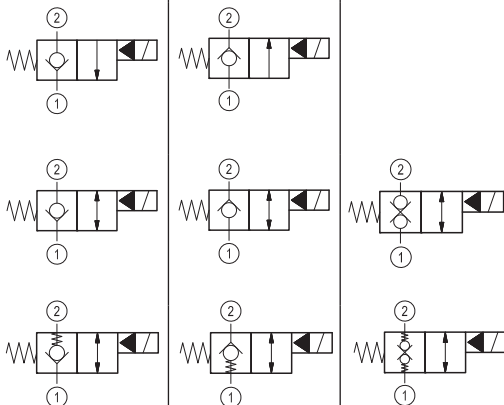
**Technical data**

General	
Weight	0.16 kg (0.35 lbs)
Installation orientation	Optional
Ambient temperature range	-30 to 60 °C (-22 to 140 °F)
Hydraulic	
Max. operating pressure	350 bar (5000 psi)
Max. proof pressure	420 bar (6000 psi)
Flow range	0.5 - 40 l/min (0.1 - 11 gpm)
Fatigue cycle life	1 million cycles at 350 bar
Max. internal leakage	20 drops/min.
Fluid temperature range	-20 to 80 °C (-4 to 176 °F)
Fluids: Mineral-based or synthetics with lubricating properties at viscosities of 20 to 380 mm ² /s (cSt)	
Installation torque	39 - 51 Nm (29 - 38 ft-lbs)
Recommended degree of fluid contamination	Nominal value max. 10 µm (NAS 8) ISO 4406 19/17/14
MTTFd	150 years see RE 18350-51
Cavity	CA-08A-2N see 18325-70
Lines bodies and standard assemblies	Please refer to section "Hydraulic integrated circuit" or consult factory
Seal kit – version 1	code material no. RG08A2010520100 R901101437
Seal kit – version 2-3	code material no. RG08A2010530100 R901101544
Seal kit coil	code material no. RG12A1PNBR7010 R934003958
Other technical data	See data sheet 18350-50
Electrical	
Type of voltage	DC voltage
Coil type	S8-356 see 18325-90
Supply voltage	See data sheet 18325-90
Nominal voltage	± 10%
Power consumption	20 W
Duty cycle coil	See characteristic curves %
Type of protection	See data sheet 18325-90
Note: Coils must be ordered separately	

Ordering code

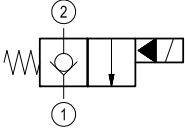
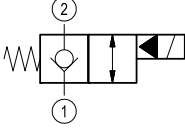
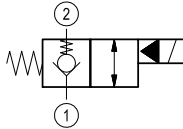
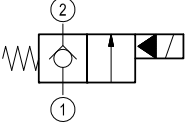
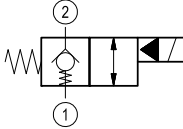
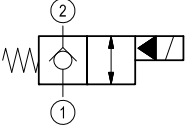
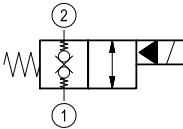
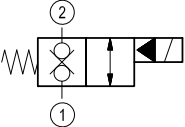
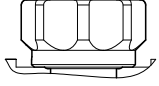
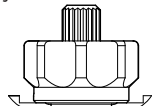
	OD.15	X	18	Y	Z
<p>Solenoid operated valves pilot operated poppet type 2-way normally closed</p>					
<p>monodirectional type</p>  <p style="text-align: right;">01</p>					<p>S0 = Tube not welded</p>
<p>bidirectional type</p>  <p style="text-align: right;">05</p>					<p>S8 = Tube not welded with extra spring</p>  <p style="text-align: right;">for X= 05</p>
<p>monodirectional type</p>  <p style="text-align: right;">09</p>					 <p style="text-align: right;">for X= 03</p>
<p>bidirectional type</p>  <p style="text-align: right;">03</p>					 <p style="text-align: right;">for X= 31</p>
<p>bidirectional type</p>  <p style="text-align: right;">31</p>					<p>standard type</p>  <p style="text-align: left;">3A</p>
					<p>knob style manual override</p>  <p style="text-align: left;">3D</p>
<p>18 = Common cavity: CA-08A-2N</p>					

Type	Material number
OD1501183AS000	R901091096
OD1501183DS000	R901091101
OD1503183AS000	R934000779
OD1503183AS800	R934003063
OD1503183DS000	R901091112
OD1503183DS800	R934003064
OD1505183AS000	R901083058
OD1505183AS800	R934003080

Type	Material number
OD1505183DS000	R901087979
OD1509183AS000	R901091150
OD1509183DS000	R901091151
OD1531183AS000	R901082015
OD1531183AS800	R934000104
OD1531183DS000	R901091164

Characteristic curves

Version 1 - Version 2

Standard

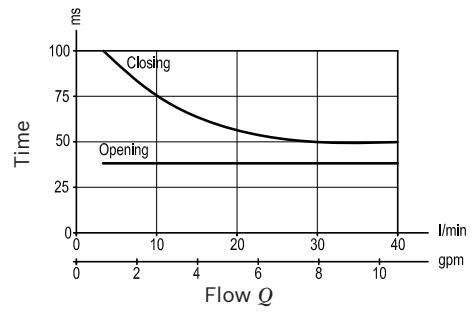
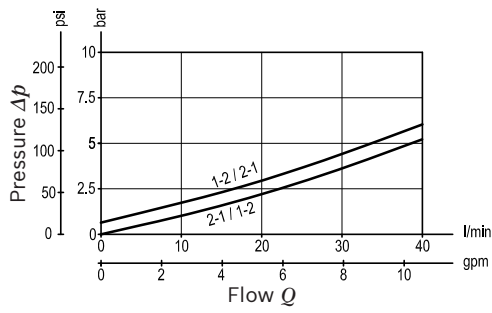

Extra spring

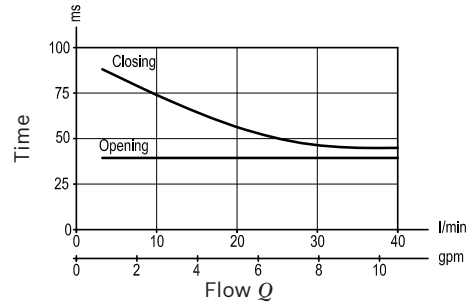
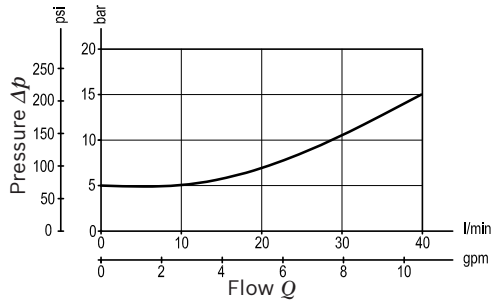

Version 3

Standard

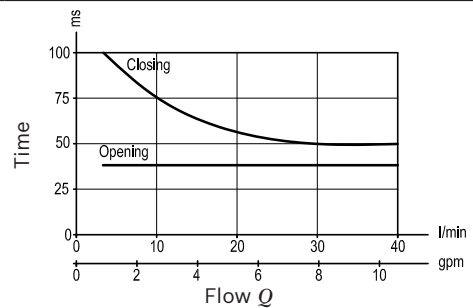
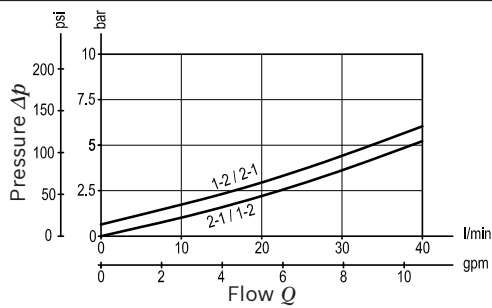

Extra spring

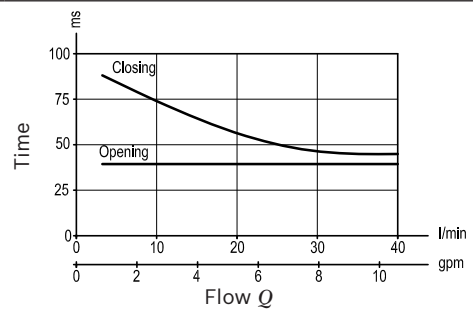
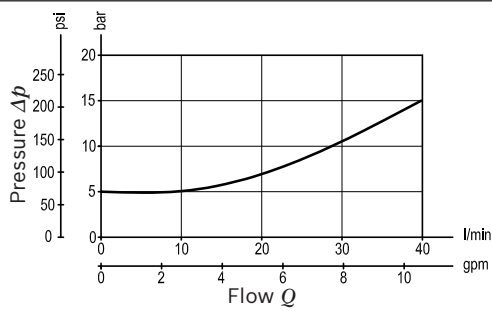

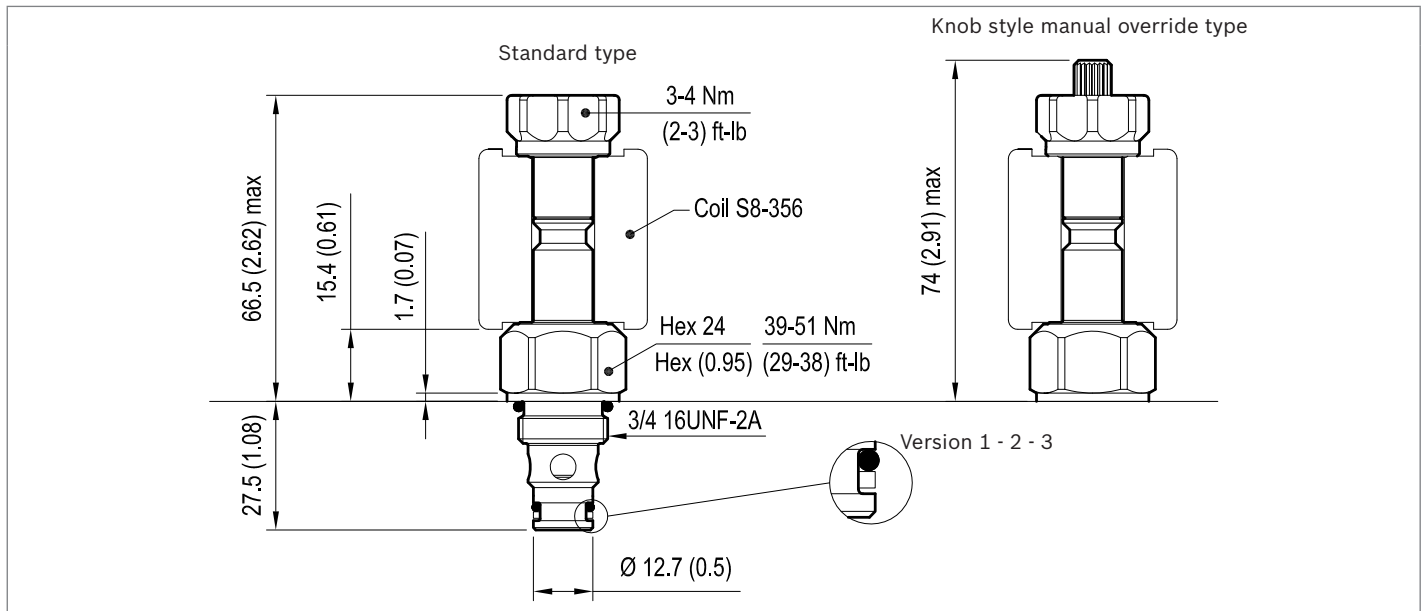
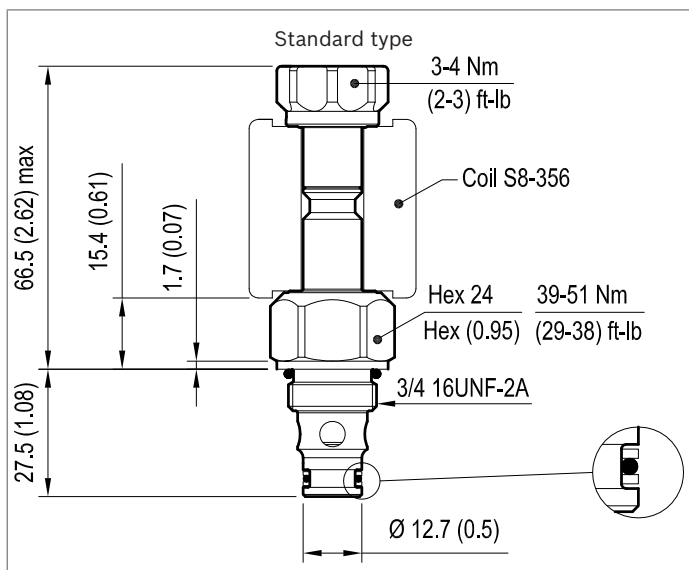
Dimensions▼ **Version 1: Solenoid operated valve, poppet 2-way normally closed**▼ **Version 2: Solenoid operated valve, poppet 2-way normally closed**▼ **Version 3: Solenoid operated valve, poppet 2-way double lock normally closed****Bosch Rexroth Oil Control S.p.A.**

Via Leonardo da Vinci 5
 P.O. Box no. 5
 41015 Nonantola – Modena, Italy
 Tel. +39 059 887 611
 Fax +39 059 547 848
 compact-hydraulics-cv@boschrexroth.com
 www.boschrexroth.com/compacthydraulics

© This document, as well as the data, specifications and other information set forth in it, are the exclusive property of Bosch Rexroth Oil Control S.p.a.. It may not be reproduced or given to third parties without its consent. The data specified above only serve to describe the product. No statements concerning a certain condition or suitability for a certain application can be derived from our information. The information given does not release the user from the obligation of own judgment and verification. It must be remembered that our products are subject to a natural process of wear and aging. Subject to change.