

Multi ports manifold / 2 ports 3/4" G / 2 ports 1/2" G **H1608**

Technical data	
Max. pressure	210 bar
Weight	0,4 Kg
Manifold material	Aluminium
Lateral ports	3/4" G
Top ports	1/2" G

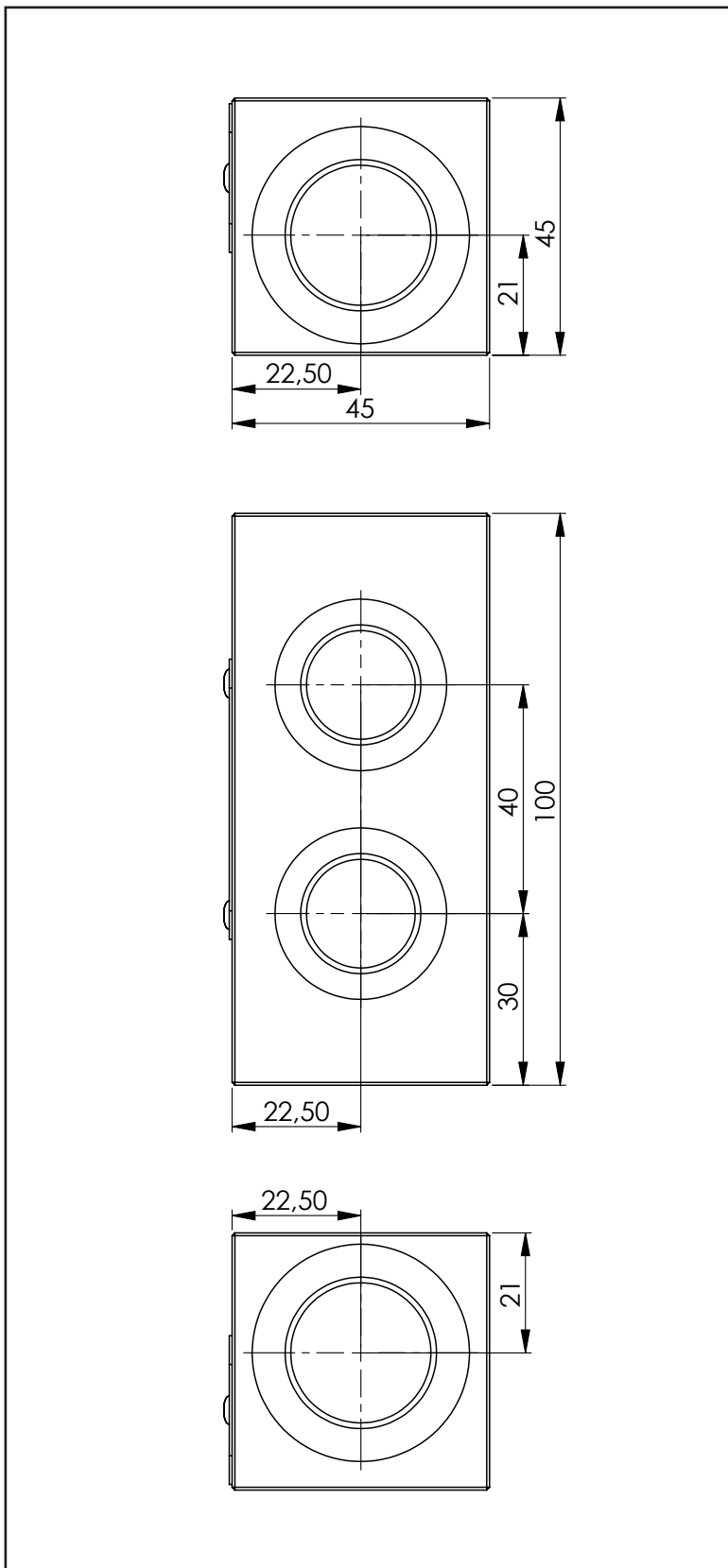
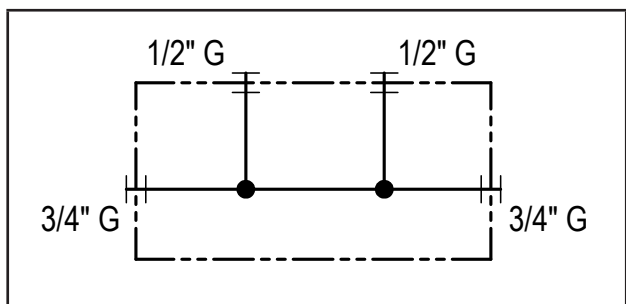
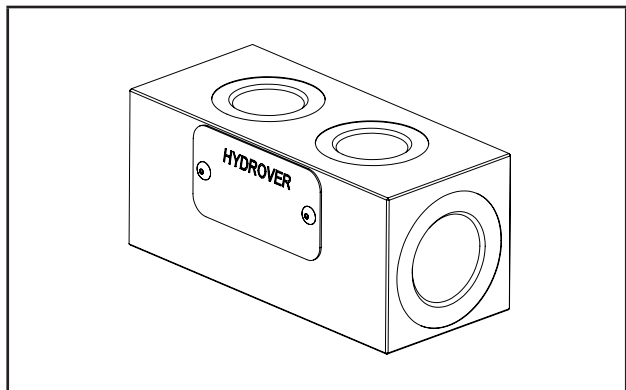

H1608

Ordering code

H	1	6	0	8	A
---	---	---	---	---	---

Hydrover product

Product series

Serie 16 - Manifolds

Manifold material

Aluminium

Product ID