

Caratteristiche tecniche	
Pressione max.	210 bar
Peso	0,4 Kg
Materiale collettore	Alluminio
Attacchi laterali	3/4" G
Attacchi superiori	1/2" G

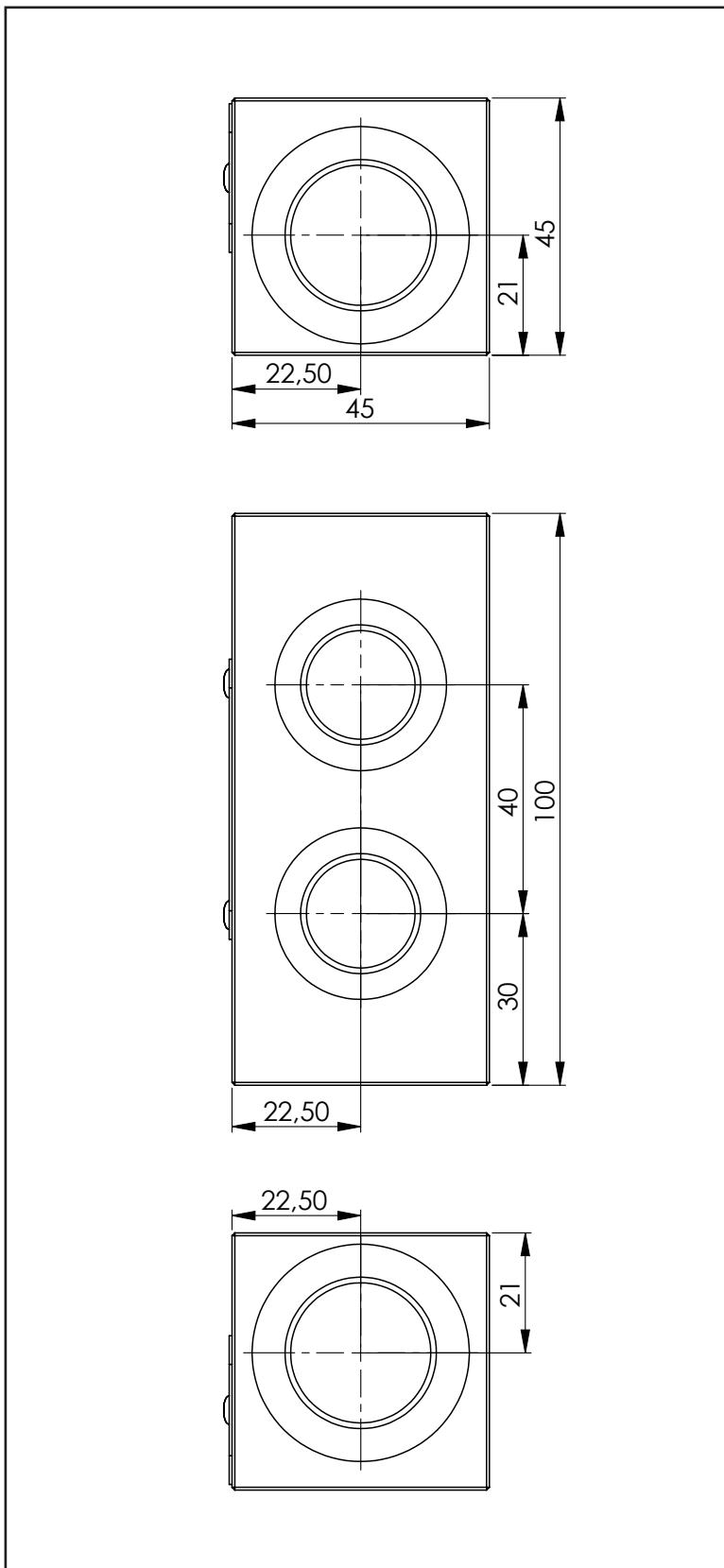
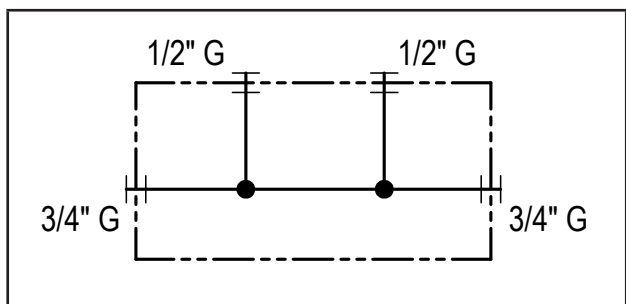
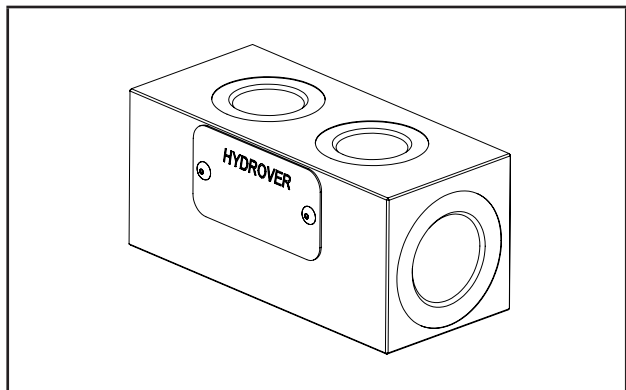

H1608

Codice d'ordinazione

H	1	6	0	8	A
---	---	---	---	---	---

Prodotto Hydrover**Materiale collettore**
Alluminio**Serie prodotto**
Serie 16 - Collettori**Indice prodotto**