

Caratteristiche tecniche	
Pressione max.	250 bar
Peso	0,7 Kg
Materiale	Alluminio
Attacchi LS / M	1/4" G
Attacchi P / T	1/2" G

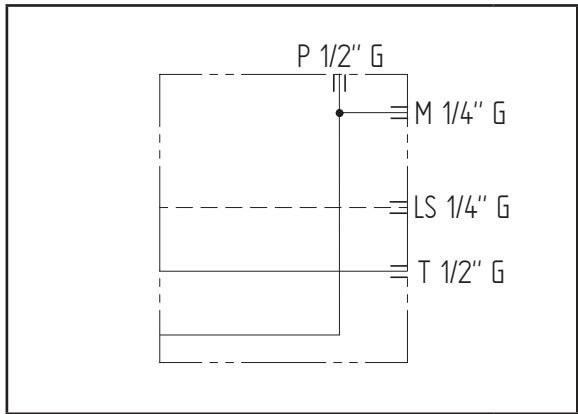

N°	Descrizione	Q.tà
1	M8 x 13 per tirante	3
2	M8 x 15 per fissaggio blocco	2

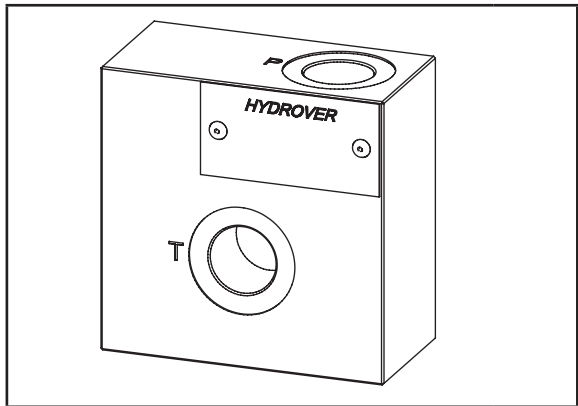
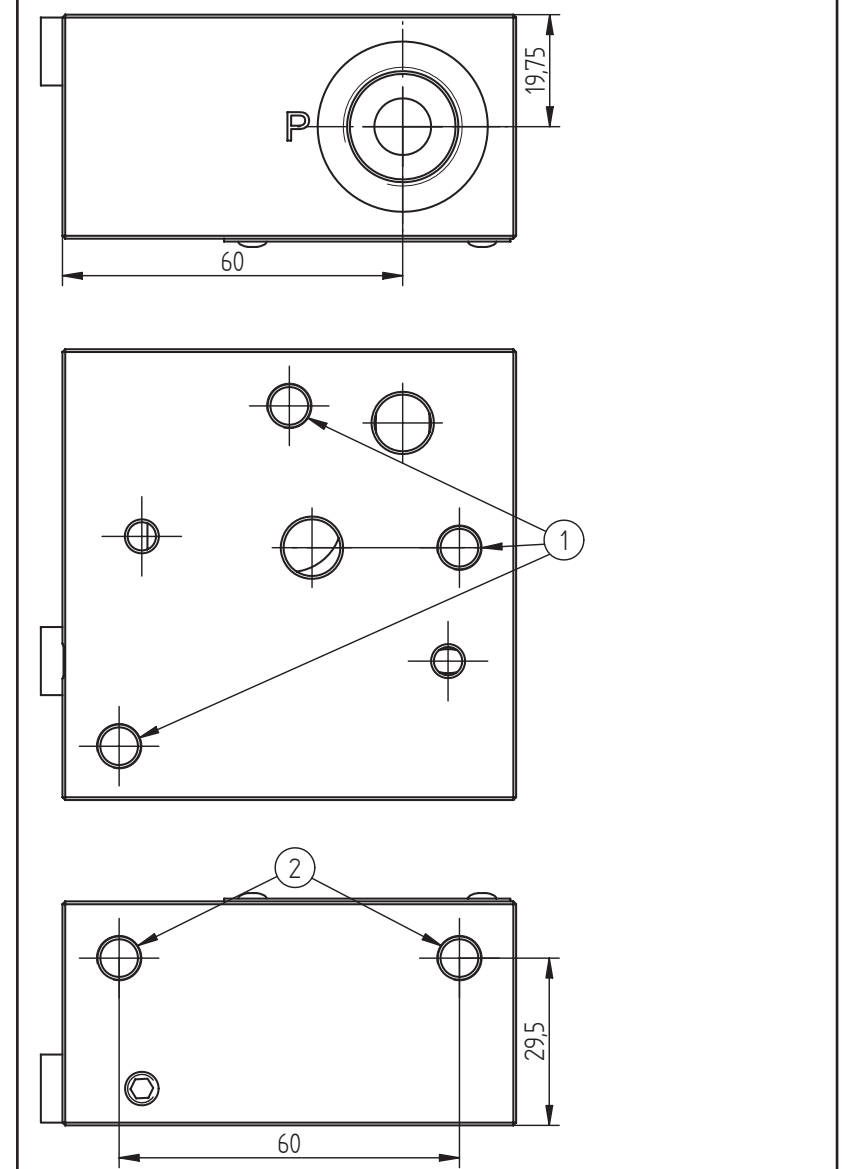

Codice d'ordinazione

H	3	2	0	3	A
---	---	---	---	---	---

Prodotto Hydrover**Materiale**
Alluminio**Serie prodotto**Serie 32 - Elementi componibili LS per valvole CETOP
3 in circuito parallelo**Indice prodotto**