

Solenoid operated valves pilot operated poppet type  
2-way normally open proximity sensor  
Common cavity, Size 08

VEI-8A-2A-06-NA-S-M-NSS

OD.15.06.18.2D.S2 - Z

**RE 18325-07**

Edition: 01.2016

Replaces: 12.2013

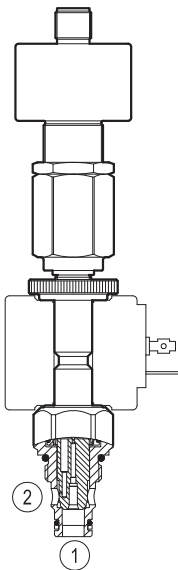
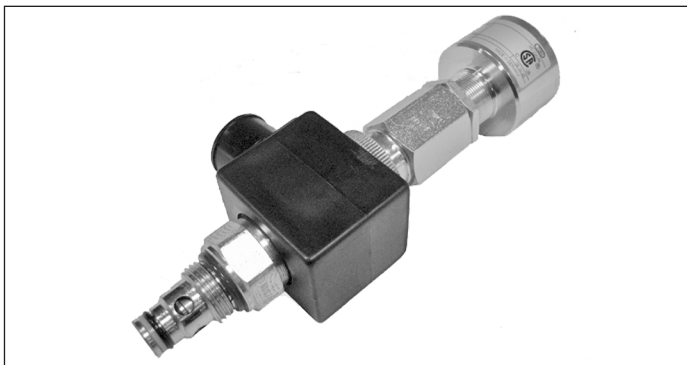

▼ Version 06

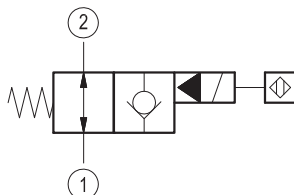

**Technical data**

General	
Weight	0.75 kg (1.65 lbs)
Installation orientation	Optional
Ambient temperature range	-25 to 60 °C (-13 to 140 °F)
Hydraulic	
Max. operating pressure	350 bar (5000 psi)
Flow range	2.5 - 40 l/min (0.66 - 11 gpm)
Max. internal leakage	15 drops/min.
Fluid temperature range	-20 to 80 °C (-4 to 176 °F)
Fluids: Mineral-based or synthetics with lubricating properties at viscosities of 15 to 380 mm <sup>2</sup> /s (cSt)	
Installation torque	30 - 35 Nm (22 - 26 ft-lbs)
Recommended degree of fluid contamination	Nominal value max. 10 µm (NAS 8) ISO 4406 19/17/14
MTTFd	150 years see RE 18350-51
Cavity	CA-08A-2N see 18325-70
Lines bodies and standard assemblies	Please refer to section "Hydraulic integrated circuit" or consult factory
Seal kit – version 06	code material no. RG08A2010520100 R930001696
Other technical data	See data sheet 18350-50

Electrical	
Type of voltage	DC voltage
Coil type	S8-356 see 18325-90
Supply voltage	See data sheet 18325-90
Nominal voltage	± 10%
Power consumption	20 W
Duty cycle coil	100 % see 18325-90
Type of protection	See data sheet 18325-90

Please consider that a proper function of the valve is guaranteed only if the position of the monitor is not modified; each cartridge is provided of a torque confirmation mark, intended as anti-tampering device.

Sensor is protected against short circuit polarity inversion.

**Ordering code**

	<b>OD.15</b>	<b>06</b>	<b>18</b>	<b>2DS2</b>	<b>Z</b>
Solenoid operated valves pilot operated poppet type 2-way normally open proximity sensor					OB 12 V DC <hr/> OC 24 V DC <hr/> Note: please consult factory for different voltages.
					Common cavity: CA-08A-2N

Type	Material number
OD1506182DS2OB	R934004821
OD1506182DS2OC	R934005243

Type	Material number

**Characteristic curves**

**Version 06**

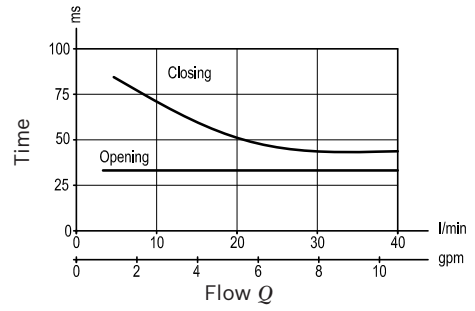
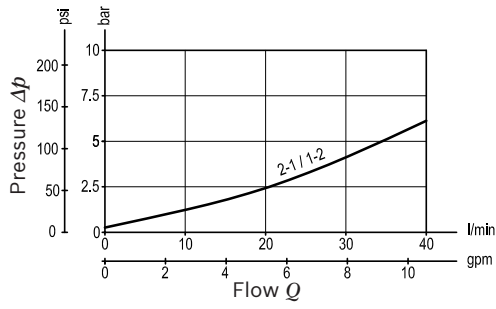

**Sensor data:**

	12 V DC	24 V DC
Supply voltage	10.5 to 16	20 to 32
Output load	≤ 400 mA	≤ 400 mA

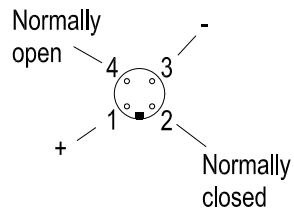
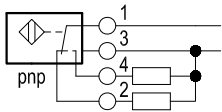

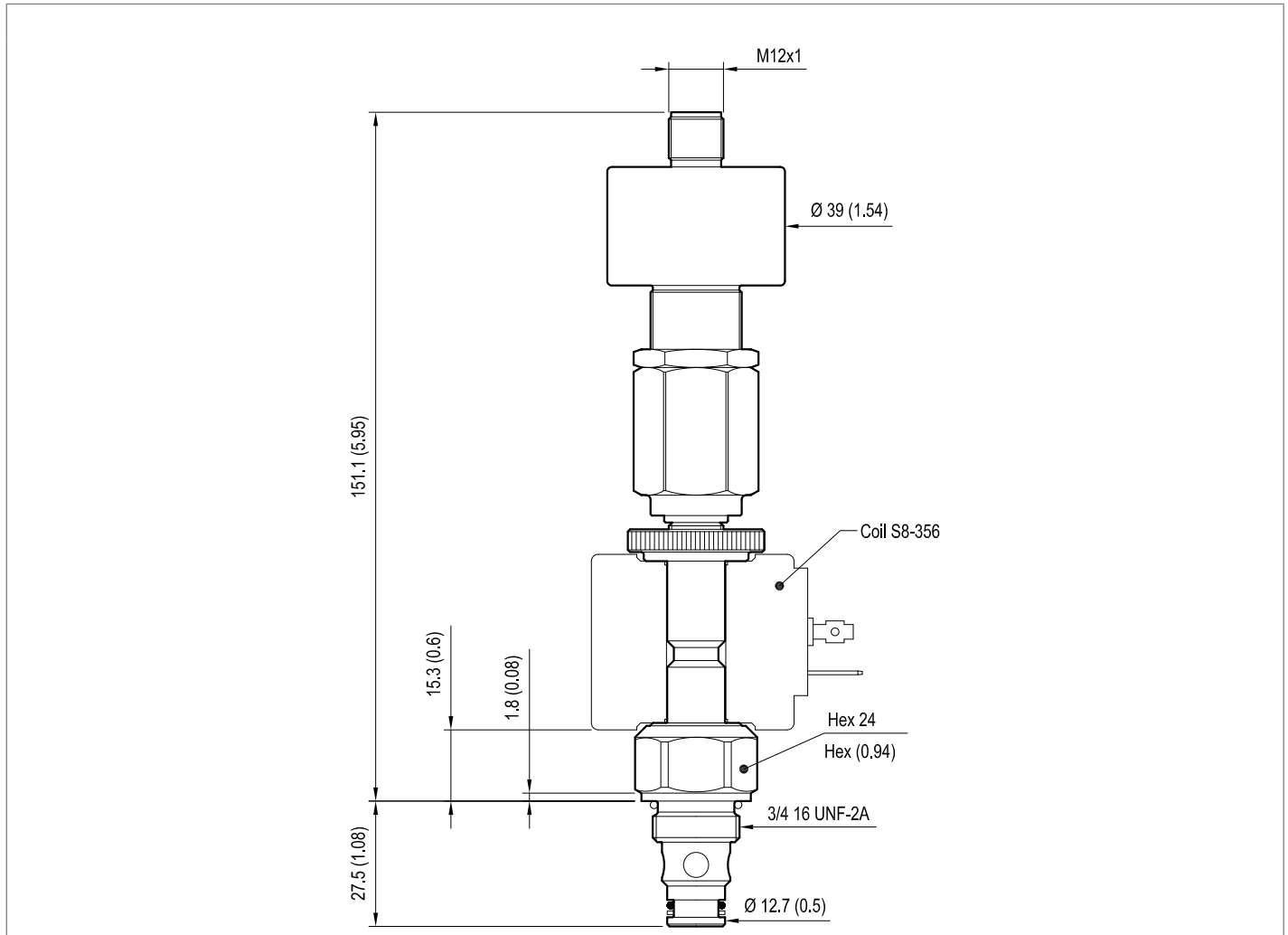
**Dimensions****▼ Version 06: Solenoid operated valve, poppet 2-way normally open proximity sensor****Bosch Rexroth Oil Control S.p.A.**

Via Leonardo da Vinci 5  
P.O. Box no. 5  
41015 Nonantola – Modena, Italy  
Tel. +39 059 887 611  
Fax +39 059 547 848  
compact-hydraulics-cv@boschrexroth.com  
www.boschrexroth.com/compacthydraulics

© This document, as well as the data, specifications and other information set forth in it, are the exclusive property of Bosch Rexroth Oil Control S.p.a.. It may not be reproduced or given to third parties without its consent. The data specified above only serve to describe the product. No statements concerning a certain condition or suitability for a certain application can be derived from our information. The information given does not release the user from the obligation of own judgment and verification. It must be remembered that our products are subject to a natural process of wear and aging. Subject to change.