

Solenoid operated valves pilot operated poppet type
 2-way normally closed double lock proximity sensor
 Special cavity, 017-E

VEI-8A-2T-09-NC-S-M-NSS

OD.15.31.17.65.01 - Z

RE 18325-17

Edition: 09.2016

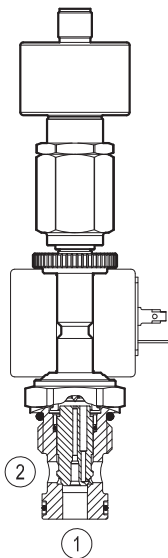
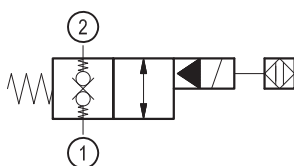
**Version 31****Technical data**

General	
Weight	0.75 kg (1.7 lbs)
Installation orientation	Optional
Ambient temperature range	-25 to 60 °C (-13 to 140 °F)
Hydraulic	
Max. operating pressure	350 bar (5000 psi)
Flow range	2.5 - 70 l/min (0.66 - 18 gpm)
Max. internal leakage	15 drops/min.
Fluid temperature range	-20 to 80 °C (-4 to 176 °F)
Fluids: Mineral-based or synthetics with lubricating properties at viscosities of 15 to 380 mm ² /s (cSt)	
Installation torque	50 - 55 Nm (37 - 41 ft-lbs)
Recommended degree of fluid contamination	Nominal value max. 10 µm (NAS 8) ISO 4406 19/17/14
MTTFd	150 years see RE 18350-51
Special cavity	017-E see 18325-90
Lines bodies and standard assemblies	Please refer to section "Hydraulic integrated circuit" or consult factory
Seal kit – version 31	code material no. RG17E201053010 R934003563
Other technical data	See data sheet 18350-50

Electrical	
Type of voltage	DC voltage
Coil type	S8-356 see 18325-90
Supply voltage	See data sheet 18325-90
Nominal voltage	± 10%
Power consumption	20 W
Duty cycle coil	100 % see 18325-90
Type of protection	See data sheet 18325-90

Please consider that a proper function of the valve is guaranteed only if the position of the monitor is not modified; each cartridge is provided of a torque confirmation mark, intended as anti-tampering device.

Sensor is protected against short circuit polarity inversion.

Ordering code

OD.15	31	17	6501	Z
--------------	-----------	-----------	-------------	----------

Solenoid operated valves
pilot operated poppet type
2-way normally closed double lock proximity sensor

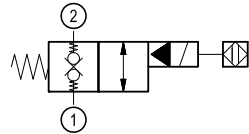

OC 24 V DC

Note: please consult factory for different voltages.

Special cavity: 017-E

Type	Material number
OD1531176501OC	R934004749

Type	Material number

Characteristic curves

Version 31

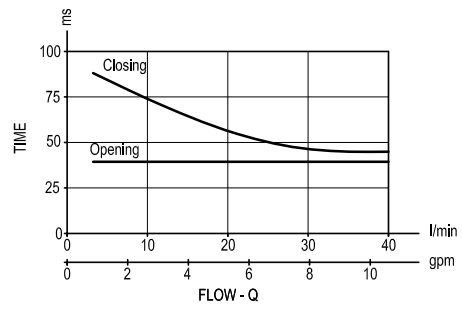
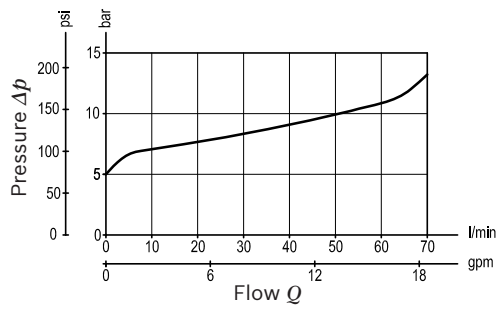

Sensor data:

	24 V DC
Supply voltage	20 to 32
Output load	≤ 400 mA

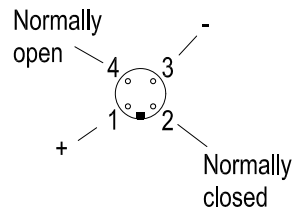
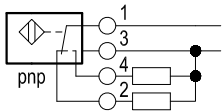

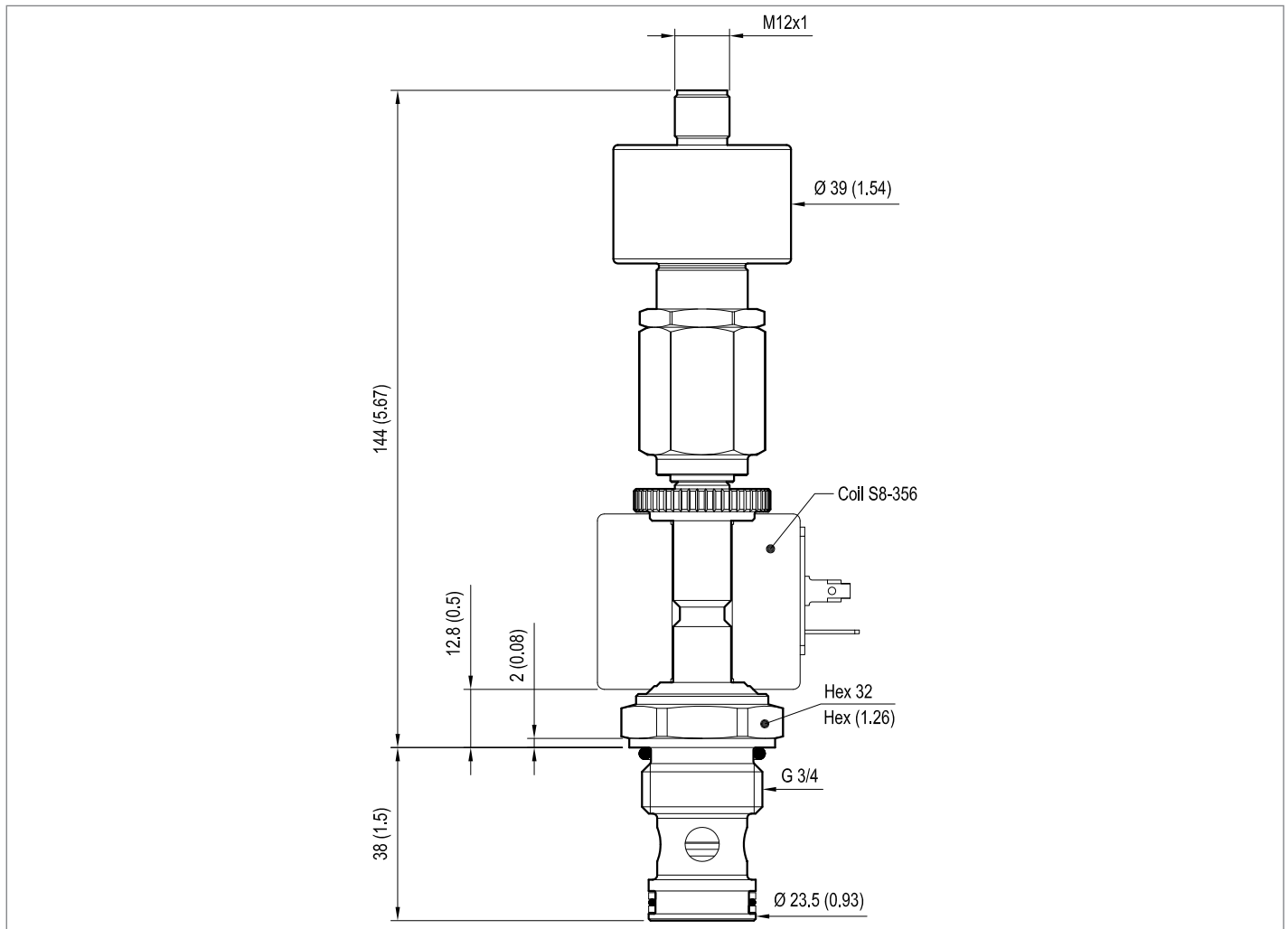
Dimensions**Version 31: Solenoid operated valve, poppet 2-way normally closed double lock proximity sensor****Bosch Rexroth Oil Control S.p.A.**

Via Leonardo da Vinci 5
P.O. Box no. 5
41015 Nonantola – Modena, Italy
Tel. +39 059 887 611
Fax +39 059 547 848
compact-hydraulics-cv@boschrexroth.com
www.boschrexroth.com/compacthydraulics

© This document, as well as the data, specifications and other information set forth in it, are the exclusive property of Bosch Rexroth Oil Control S.p.a.. It may not be reproduced or given to third parties without its consent. The data specified above only serve to describe the product. No statements concerning a certain condition or suitability for a certain application can be derived from our information. The information given does not release the user from the obligation of own judgment and verification. It must be remembered that our products are subject to a natural process of wear and aging. Subject to change.