

## Proportional valves not compensated flow regulator

Common cavity, Size 12

VEP-5A-2Q-14

OD.92 - X - 12 - Y - 00

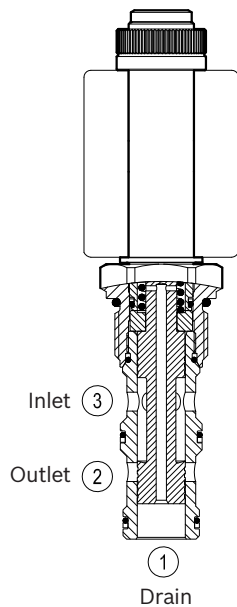

Version 03

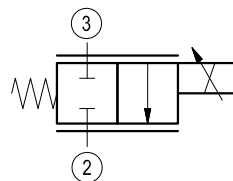

Version 05

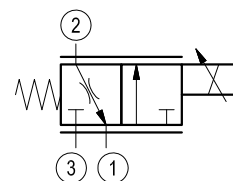

Version 03: port 1 not used.

### General

Weight	kg (lbs)	0.39 (0.86)
Installation orientation		Optional
Ambient temperature range	°C (°F)	-30 to 60 (-22 to 140)

### Hydraulic

Max. operating pressure	bar (psi)	210 (3000)
Flow range	l/min.(gpm)	5-60 (1-16)
Max. internal leakage (*)	cm <sup>3</sup> /min. (cu.in./min.)	190 (12)
Fluid temperature range	°C (°F)	-20 to 80 (-4 to 176)

Fluids Mineral-based or synthetics with lubricating properties at viscosities of 15 to 380 mm<sup>2</sup>/s (cSt)

Installation torque Nm (ft-lbs) 54-66 (40-49)

Recommended degree of fluid contamination Nominal value max. 10µm (NAS 8) ISO 4406 19/17/14

Cavity CA-12A-3N see RE 18325-70

Lines bodies and standard assemblies Please refer to section "Hydraulic integrated circuit" or consult factory

Seal kit code RG12A3010520100 material no. R930000941

Seal kit coil code RG19A1PNBR7010 material no. R934003964

Other technical data See data sheet RE 18350-50

(\*) Measured at 210 bar (3000 psi). Oil at 46 cSt.

### Electrical

Type of voltage	DC voltage
Coil type	S5
Supply voltage	12 DC
Nominal voltage	± 10%
Power consumption	W 23
Duty cycle	% 100
Type of protection	See data sheet RE 18325-90

Note: Coils must be ordered separately.

# Dimensions

## Proportional valves not compensated flow regulator

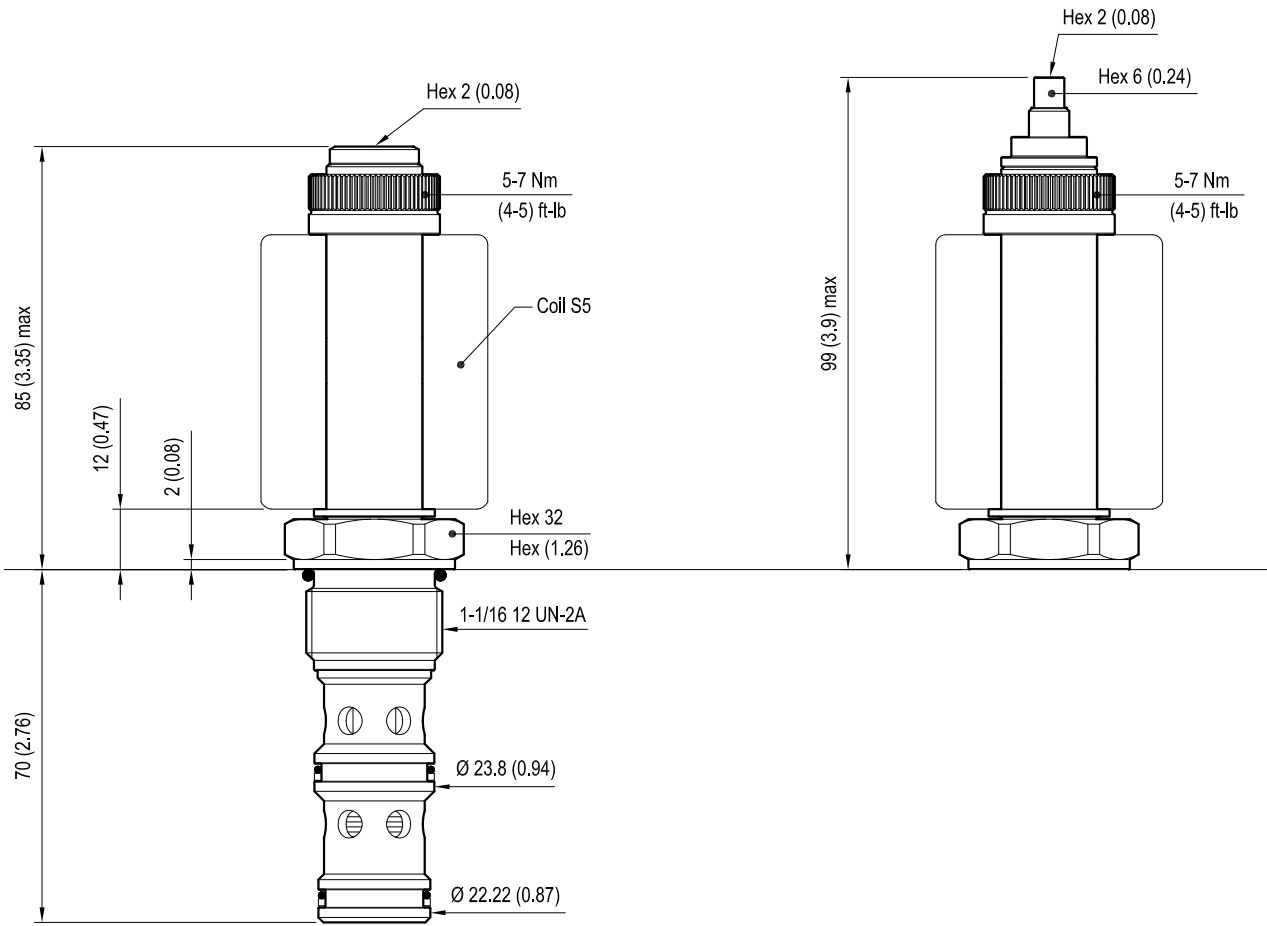

Version 03  
PORT NOT USED

mm (Inches)

### Performance graphs

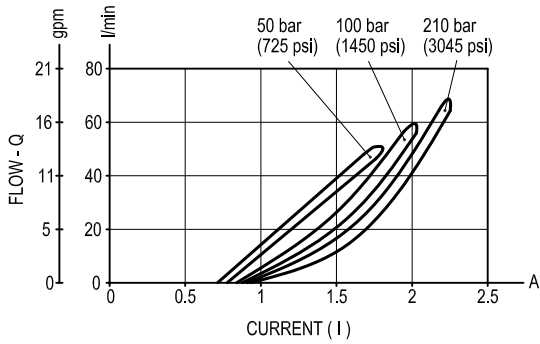
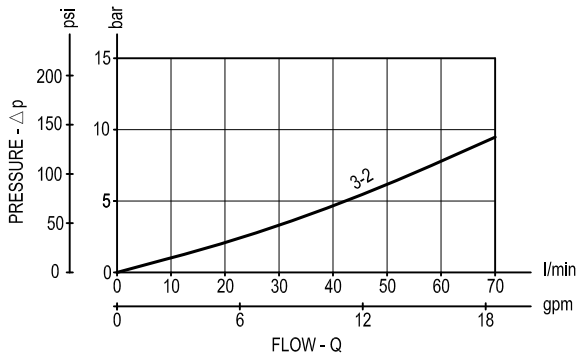

		I	P bar (psi)	Coils
Z=00	I min:	0.75 A	210 (3000)	12 DC
	I max:	2.1 A	210 (3000)	12 DC
PMW Frequency: 150-180 Hz				
Hysteresis: < 5%				

Note (1): It is recommended to use coil 12 DC.  
 Note (2): Performance using coil without diode.

### Ordering code

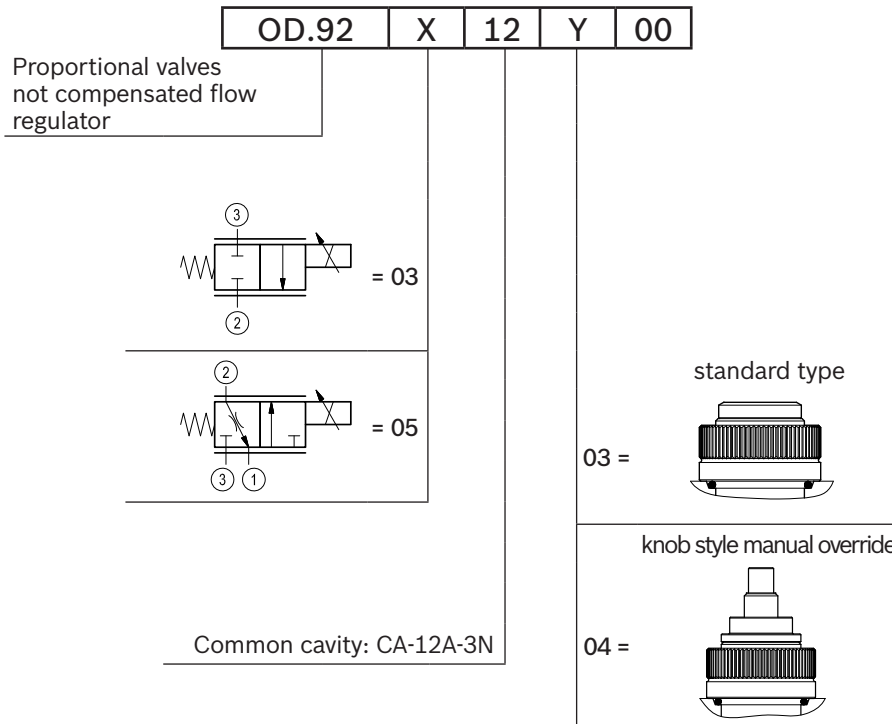

Type	Material number	Type	Material number
OD920312030000	R934001514		
OD920312040000	R934001515		
OD920512030000	R934001523		
OD920512040000	R934003910		