

Standard integrated circuit solenoid operated ventable relief valve

VSP-19-VEI-16-08A

OL - K - Y - Z - X - W - 00

RE 18332-48

Edition: 02.2019

Replaces: 12.2016

Dimensions

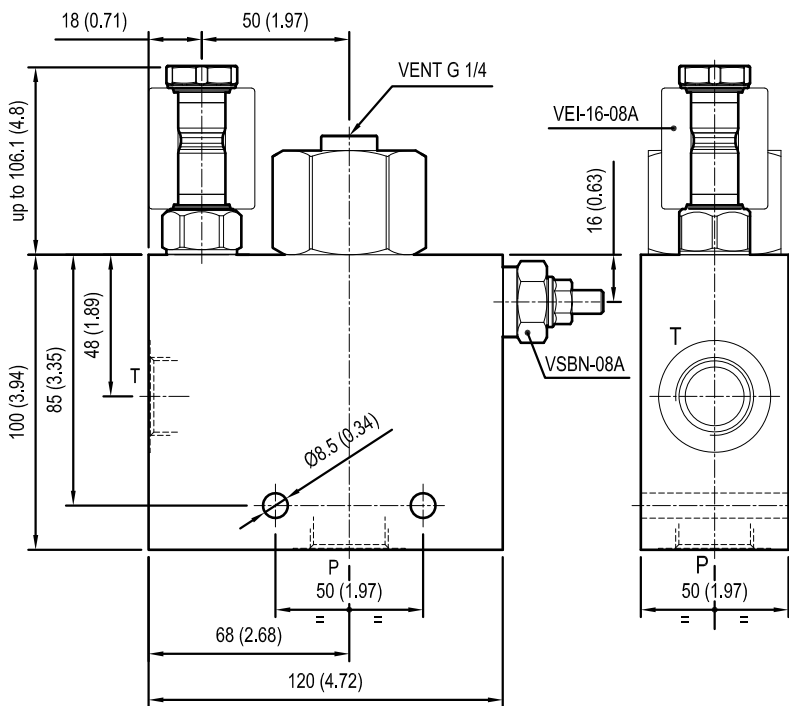

Configurations available (K)

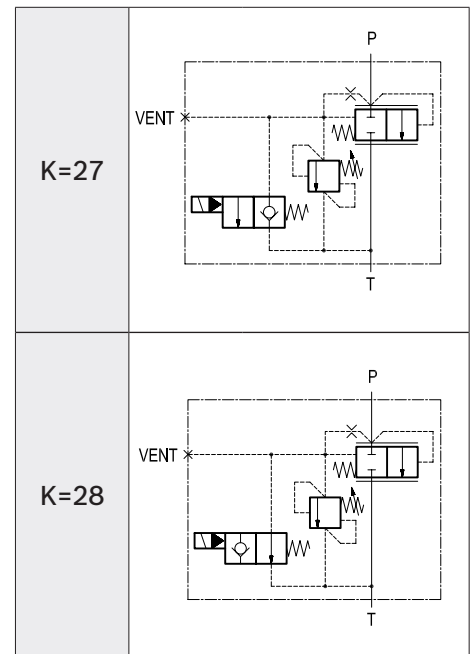

[mm (inches)]

Technical data

Max. flow: up to 200 l/min (53 gpm)

Max. operating pressure: 210 bar (3000 psi)

Standard manifold in high strength aluminium.

For working pressure up to 350 bar (5000 psi) and for fatigue applications with any working pressure, steel manifolds are available upon request.

Weight: 1.3 kg (2.9 lbs)

Fluids: Mineral-based or synthetics with lubricating properties at viscosities of 20 to 380 mm²/s (cSt)

This integrated circuit contains one relief valve type VSBN-08A operating from P to T and one solenoid valve type VEI-16-08A

Other technical data See data sheet 18350-50

Cartridge valve VSBN-08A (see data sheet 18318-01)

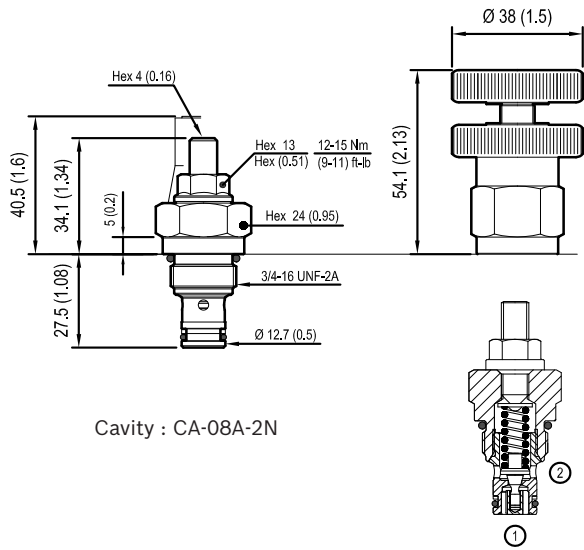

Cavity : CA-08A-2N

Z	VSBN-08A Setting		
	Adj. pressure range bar (psi)	Press. increase bar/turn (psi/turn)	Std. setting bar (psi) (Q=5 l/min)
	01 35-140 (500-2000)	50 (725)	100 (1450)
	04 105-210 (1500-3000)	79 (1145)	200 (2900)
	07 175-350 (2538-5000)	170 (2465)	350 (5000)
	08 35-350 (500-5000)	72 (1044)	350 (5000)

ADJUSTMENTS		OPTIONS
Leakproof hex. socket screw		 Tamper resistant cap 11.04.23.002
Handknob and locknut		

Solenoid cartridge valve VEI-16-08A
(see data sheets 18323-25 and 18323-26)

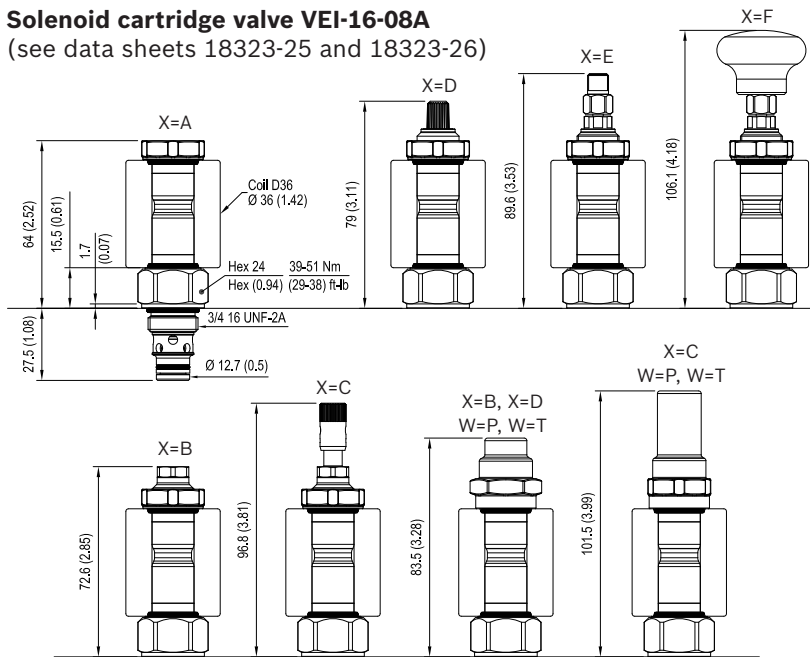

Technical data

General	
Installation orientation	Unrestricted
Ambient temperature range	-30 to 90 °C (-22 to 194 °F)
Hydraulic	
Max. operating pressure	350 bar (5000 psi)
Flow range	0.5 - 40 l/min (0.1 - 11 gpm)
Max. internal leakage	5 drops/min.
Switching time	Opening ≤ 50 ms Closing ≤ 100 ms
Fluid temperature range	-20 to 80 °C (-4 to 176 °F)
Fluids:	Mineral-based or synthetics with lubricating properties at viscosities of 20 to 380 mm ² /s (cSt)
Installation torque	39 - 51 Nm (29 - 38 ft-lbs)
Recommended degree of fluid contamination	Nominal value max. 10 µm (NAS 8) ISO 4406 19/17/14
MTTFd	150 years (see 18350-51)
Cavity	CA-08A-2N (see 18325-70)
Other technical data	See data sheet 18350-50
Electrical	
Type of voltage	DC voltage
Coil type	D36
Supply voltage	See data sheet 18325-90
Voltage tolerance against ambient temperature	See characteristic curve
Power consumption	20 W
Type of protection	See data sheet 18325-90

Note: Coils must be ordered separately

TAB. 1 Manual override options (X)

Seal and prot. cap. (W)	Manual override options (X)					
	A	B	C	D	E	F
O	K=27 K=28	K=28	K=28	K=27	K=27	K=27
V	K=27 K=28	K=28	K=28	K=27	K=27	K=27
P	/	K=28	K=28	K=27	/	/
T	/	K=28	K=28	K=27	/	/

Characteristic curves

VSP-19-VEI-16-08A

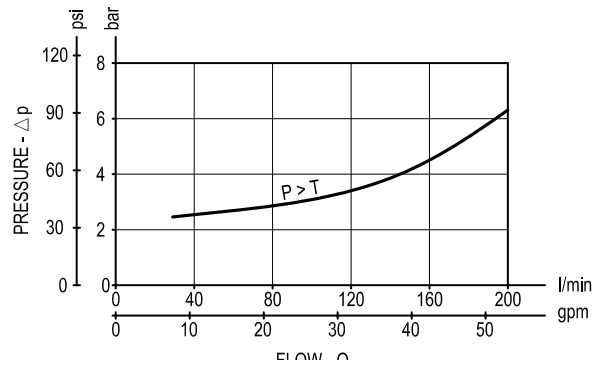

VEI-16-08A all Versions - Admissible supply voltage Vs. Ambient temperature at 100% duty cycle

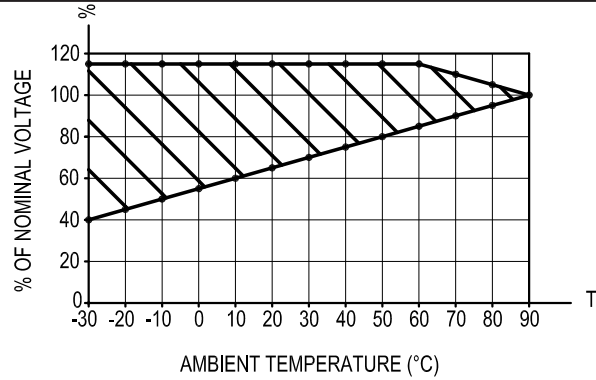

VSBN-08A

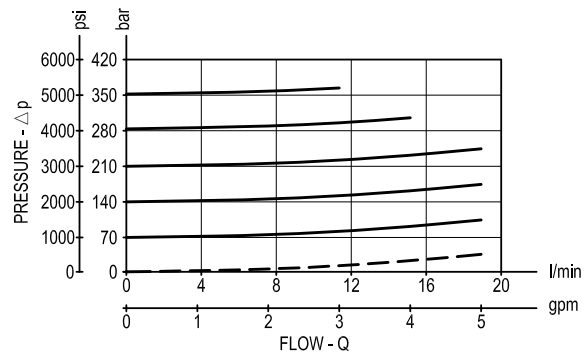

Ordering code

OL	K	Y	Z	X	W	00
-----------	----------	----------	----------	----------	----------	-----------

Standard integrated circuit
solenoid operated ventable
relief valve

Configuration **K = 27**

Configuration **K = 28**

Ports size	P - T
= 04	G 3/4
= 05	G 1

Cartridge VSBN-08A setting
see page 2

Solenoid cartridge seals and accessories options

O = With buna seal

V = With Viton seal

P = With buna seal and protective cap for override version **B, C** and **D**

T = With Viton seal and protective cap for override version **B, C** and **D**

Solenoid cartridge options

A = Standard

B = Push style manual override

C = Push and twist style manual override

D = Knob style manual override

E = Pull style manual override

F = Hand operated pull style manual override

Note: for solutions availability (K-X-W combinations),
please refer to TAB.1 on page 2.

Bosch Rexroth Oil Control S.p.A.

Via Leonardo da Vinci 5

P.O. Box no. 5

41015 Nonantola – Modena, Italy

Tel. +39 059 887 611

Fax +39 059 547 848

compact-hydraulics-hic@boschrexroth.com

www.boschrexroth.com/compacthydraulics

© This document, as well as the data, specifications and other information set forth in it, are the exclusive property of Bosch Rexroth Oil Control S.p.a.. It may not be reproduced or given to third parties without its consent. The data specified above only serve to describe the product. No statements concerning a certain condition or suitability for a certain application can be derived from our information. The information given does not release the user from the obligation of own judgment and verification. It must be remembered that our products are subject to a natural process of wear and aging. Subject to change.